

# Miniature Arms

SPRING 2006

The Journal of the  
Miniature Arms  
Collectors/Makers  
Society



The Worlds Biggest Miniature Arms Publication

## Roger Sampson Master Mini Engraver



Photo by Roger Sampson

Also in  
this issue



Eight Pages  
of Collectors  
Arms Show  
News.

The Early  
Days of  
Artillery

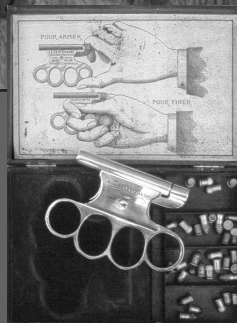

Knuckle-  
duster  
Minis

# The Miniature Arms Journal



President ..... Bill Adrian  
Vice President ..... Mal Mele  
Secretary ..... William Adrian  
Treasurer ..... Alice McGinnis  
Directors ..... Bill Adrian  
..... Dr. Paul Kopsch  
..... Ken Whichard  
..... David Kucer  
..... Michael Barrett  
Corporate Agent ..... James Schmidt  
Publisher ..... David Hall  
Editor/Art Director ..... Bob Urso  
Contributing Editor . Ralph Koebbeman  
Western News ..... Gil Metcalf  
Membership Chairman .. William Adrian  
Exhibit Director - Bob & Alice McGinnis  
Plan Librarian ..... Roland Friestad  
Webmaster ..... Dr. Brad Maxfield

*The Miniature Arms Journal* (formerly *Shooting The Breeze*) is published four times a year for and by the members and friends of the Miniature Arms Collectors/Makers Society, Ltd. Membership dues are \$30 per year for the North American members and \$35 per year in U.S. funds for all international members. For a family membership add \$10 (we only send one copy of MAJ to the one address). Dues are due on the first of the year. First year dues and joining fees are \$40 and \$45 respectively. Dues include the four issues of *The Miniature Arms Journal*. New members will receive all available back issues in the current volume. Dues (checks made out to the Miniature Arms Society) and correspondence concerning membership should be sent to

**Alice McGinnis**  
**2109 Spring Street**  
**Cross Plaines, WI 53528**  
**Tel. (608) 798-2860**

## Society Officers 2006

### President

William Adrian  
2502 Fresno Lane  
Plainfield, IL 60544  
Tel.(815) 254-8692

### Treasurer

Alice McGinnis  
2109 Spring Street  
Cross Plaines, WI 53528  
Tel. (608) 798-2860

### Membership Chairman

William Adrian  
2502 Fresno Lane  
Plainfield, IL 60544  
Tel.(815)254-8692

## The Presidents Message

Tuesday, March 7, 2006

Dear Members and Friends:

The first quarter of 2006 has been very noteworthy for the MAS from a publicity standpoint. The Illinois Rifle Association ran an article on our award-winning maker Michel LeFaivre which took the entire back page of their tabloid-style newspaper! The piece was nearly identical to the feature story Bob Urso ran in the Spring issue of our magazine in 2004, so I don't think we'll re-print it. I will ask the Illinois Rifle Association if they would be interested in similar articles in the future.

The second item was a slight mention in a Wall Street Journal by Jeff Zazlow. The story concerns the lack of interest that the younger folks seem to have in the collections of their fathers and grandfathers. The Journal author seemed to think the reason for this dis-connect had something to do the current electronic blitz of iPods, x-boxes, etc., a conclusion which I might dispute, but it doesn't matter. The indirect result of this "mention in passing" was that the large metropolitan newspaper "The Chicago Sun-Times" picked up on the story and called me for their own story focusing more specifically on the miniature arms (although the theme remained 'nobody cares'). It remains to be seen if any interest in the club is generated by any of these exposures. Fifteen minutes of fame.

Back to reality. Remember the NRA Convention in Milwaukee, Wisconsin May 19-21, 2006 at the Midwest Airline Center! Information, reservations, maps, etc. are all available at [www.nra.org](http://www.nra.org). All of us in the Midwest should make every effort to attend and put faces and personalities with the names and addresses we see in the Journal. I promise you won't be sorry!

Till we see each other at our display tables in Milwaukee, "Live long and Prosper"

Bill Adrian,  
President, secretary, membership chairman, and garage sale coordinator

MAS-MEMSHIP@msn.com  
Tel.(815)254-8692





# From the Editor



You should be receiving this issue some time in April. As you read it, think about your humble editor eating pasta in some inexpensive trattoria someplace in Florence.

That's right, I'm on the road again. One of the advantages of being a university professor. You don't get rich, but you do get benefits like sabbatical leaves. What am I doing in Florence? Drawing and painting "naked" people, one of my favorite activities, after making mini's. It's also what I teach for the most part.

I'll be back by May 10, but if you need to get in touch with me before that, I will be reading my email every few days or so, while in Italy.

The Vegas "Collectors Arms" show was a great occasion for MAS members to get together. There were over fifteen members that stopped by the MAS table, many meeting for the first time. As expected there was lots of good mini talk, and also some good eats as we gathered for a large group supper on Saturday evening. The Mandalay Bay sure does a buffet that's hard to beat.

Thanks to Kebby, Roger Sampson, Ron DeWalt, Antonio Rincon, and Sterling Kopke for helping out with this issue. Contributions are much appreciated.

All the best,  
Bob Urso

1806 Samish Way  
Bellingham, WA 98229  
Tel. 360/733-4406  
[boburso@boburso.com](mailto:boburso@boburso.com)

## In This Issue

The Presidents Message .....	2
Letters & email .....	4
High School minis from Ron DeWalt .....	7
The Latest from Antonio Rincon .....	8
Las Vegas Scrapbook: Members Gather at Collectors Arms Show .....	10
Las Vegas Scrapbook Members Guns on Display .....	12
Las Vegas Scrapbook Mini Knives on Display .....	16
Roger Sampson: Premier Mini Engraver .....	18
Making a Miniature Pistol Holster by Sterling Kopke.....	21
Kebby's Korner: The Early Days of Artillery by Ralph Koebbeman .....	24
The Pinfire Page by Bob Urso .....	28
2mm Knuckle Dusters The Wahl's Patent & Le Centenaire by Bob Urso .....	29
Wired.....	32
Shop-r-Swap .....	34
Books by MAS Members .....	35

# Letters



## &connections

Dear Bob,

Just a quick note to congratulate you on a splendid spread in tribute to John Cooper.

That said, it is a bumper edition. In fact the Journal has been getting better and better.

Best Wishes  
RobinArmstrong

**ED.** I think all of our readers agree that Robin played the larger part in making the tribute to John as good as it was.

---

### A Third John Cooper book on Miniatures.

Before he died John left 3 manuscripts on miniatures entitled: Percussion Revolvers, Revolvers with Hinged Sideplates and Percussion Box Lock Pistols. These provide supplemental information to that already published in his first two books on miniatures. These 3 monographs if published together would produce a book about the same size as his last one on German Military Revolvers.

As a tribute to John I would like to get these published. He had assembled all the necessary photo-

graphs for the illustrations apart from two. I would be grateful if any MAS member could help me locate these miniatures and/or provide me with a high quality photograph (digital or transparency) suitable for illustrating John's book. It is likely that he had already been in communication with the owners of these miniatures though I can find no record of it. The miniatures in question are:

- A miniature Adams' revolver with Tiffany style decoration. It was originally bought by John Astor at the World Fair, Chicago in 1892 from the Tiffany stand.

- A miniature Adams' revolver with exceptional decoration over a gilded finish, cased with accessories. It is illustrated in Merryl Lindsay's book on miniatures at page 94 where it is referred to as a Tranter revolver and was then with the Berger collection.

Your help would be much appreciated."

Once again, Christmas Wishes  
Robin Armstrong  
jandr.armstrong@virgin.net

---

### Patents???

Thought you might like to see what I came upon... happy new year

[http://vintage-reprints.com/catalog/advanced\\_search\\_result.php?keywords=guns&sort=2a&page=2](http://vintage-reprints.com/catalog/advanced_search_result.php?keywords=guns&sort=2a&page=2)

David Perkins

**ED.** You can get any patent for free if you know the number. Check out. <http://www.uspto.gov/patft>

---

### 4mm ???



Hi Bob,

Today at a gun show I purchased a 4MM rimfire revolver. This appears to be pre 1900 and is very petite and delicate looking. It has a 6 shot cylinder.

Would you, or any of y;our members, possibly have any information on vintage sub caliber revolvers?

This one has no name or proof marks. Only the number 14 on some of the parts. It measures 4 1/2" overall length. The barrel by the way is not rifled.

Thanks,  
Jim Hickey  
El Cajon, CA  
[jim739@earthlink.net](mailto:jim739@earthlink.net)



This photo shows a .22 short for comparison.



---

## TranterPlans???

Hello Bob

Back in the October 1999 issue on page 16 is an article that John Cooper sent in on a miniature Tranter pistol he made. I would like to try making one of these and was wondering if you might have any other pics/plans for these or know of where they might be obtained.

Thanks,

Jon Heinz

---

## Of Springs and Mergers...

Hi Bob,

I have a couple of things I would like to put before you. The first is about small coil springs for mini pistol triggers, etc. Sometime back we had a discussion on winding, etc because very small springs are hard to find. The other day I was putting a band on a wrist watch when the expansion spring bar fell apart; out popped a beautiful little coil spring. Spring bars come in several diameters & lengths. I thought this might be of interest to you & MAS Members for a small coil spring source.

The second thing is: In one of the past MAS I read an article of Ralph Koebbeman encouraging members to join the Miniature Knife Society. I sent in my membership. It was right at the time Terry Kranning was killed in an accident. I joined but it looks like the Miniature Knife Society is on shaky ground. Like you, they are having trouble getting their 100 members to contribute.

I just sent Gary Kelley dues & mentioned since Miniature Arms & Knives go well together it seems it

would be beneficial for both groups to merge. I can see where it could make a much stronger organization. I am emailing you a copy of the correspondence with Gary Kelley. You can pursue it if it sounds interesting to you.

Sincerely, Sterling Kopke

**ED** Here is the email Sterling received from The MKCS

Sterling,

I appreciate your e-mail. Combining the two miniature societies might be a good idea. I'd like to hear more about that from the members. What would be the advantages?

I'm only a stop-gap editor of the MKCS newsletter. I haven't made miniatures in a while, but I hated to see the Society go under. I wonder if the Miniature Arms Society would be interested in the idea. I know several of our members, like yourself, are members of both.

I used to make miniature lather sheaths, but gave it up. I couldn't keep the stitching from pulling out after I had thinned the leather enough to make a mini sheath. I'd really be interested in your telling us how you do it. If you could email me the info I'd be glad to put it in the newsletter.

At any rate, thanks for staying with us for another year. I'd appreciate any advice you could give on making our newsletter better. Thanks for the good wishes for 2006. I need them. Some lady on a cell phone rear-ended my Jeep three weeks ago. Totaled the Jeep, and I got a whiplash. I'm getting better, but the headaches are annoying. I hope I get over it quickly.

Sincerely, Gary Kelley

---

## Gun Laws in Chile

Dear Mr Urso:

Thank you for your prompt reply I hope you can use this: I want to give you information (about the) Gun Control Laws in Chile, as an example of how bureaucratic laws can affect a society.

The Socialist Party, now in power, changed on October 1, 2005, law No. 20,014 from the old - but working - law (established in 1973) to one with much harsher controls. Putting the police under political control, allows the leftist government to use as a base the powerful OS-9 and its detective polices, directed by corrupt courts as tools to prosecute everyone

So there is a need to be very careful. Most of these injustices involve new and old firearms, but cases on "Illegal Gun Possession" for toy, air, CO2 or blank guns are common. The law establishes "Firearms Control, regardless of caliber and parts and pieces".

Our Gun Control Dept is unclear on these points, Logic tells us: "Air, CO2 and Paintball guns should not have controls of any kind" ... on Miniatures and Models "They need a case by case examination, but as a general rule do not need any controls"

The laws are not clear in my opinion, but my (miniatures) model's small scale and muzzleloading nature excludes me from these controls, but any hysteric judge or police might think differently. I do not want this to sound like an N.R.A. protest letter, but it is unavoidable: lots of my honest friends and law abiding customers are in jail today, some uncharged for months awaiting trial.

Sadly, working in any gun related field, even the most innocent are guilty I must start looking for new horizons in other places, which is a shame

since my ancestors fought in War and Peace for this beloved country.

May God not permit you to suffer the same !! Sorry for this long letter, but I hope that this knowledge can be of some help.

Yours Very Truly,  
LUIS HERNANDEZ MUÑOSTES.  
Chile

---

### Kucer to receive

The April issue of Home Shop Machinist features member David Kucer, who will receive, at this years Model Engineering Show, the Sherline Co, Craftsman of the Year Award.

David will be presented the award on April 22., and we hope to have more information, and possibly a reprint of the Home Shop Machinist article in the Summer issue of the Journal.

Alice McGinnis

---

### Mini Knives

Hi Mr. Urso,

My name is Brian Jacobson, I am a miniature knife maker. One of my buyers informed me that one of my knives was featured in your Quarterly Journal. He said it appeared on page 7 and was described as being "auctioned on Ebay". I was curious of the nature of the article and how my knife managed to make it in your journal. I understand that you feature some very nice knives and am flattered that you would include mine as well.

I'm still very new at all this and am very happy being a part of it. If possible I'd like to receive a copy of the journal. I am considering becoming a member as well but would like to get the copy asap if possible. Please let me know if it's possible and any costs that may be associated with it.

Thanks for your time,  
Brian Jacobson

ED. Will do, as soon as I get'em.

---

### Member website...

Hey Bob,

I'm a member (re-upped last year), have a web-site, and an e-address, but neither appear in "Websites worth checking out...", or "Wired". Could you...? (Yeah... the society has them, 'cause there was an article about my work last year, in which both were listed). My website can be found at [www.georgewjones.com](http://www.georgewjones.com)

Thanks,  
G. Jones  
email [moviemodels4@aol.com](mailto:moviemodels4@aol.com)



Here's a little whistle gun that I found while searching the internet. ED.

## Complete MAS Plans Library Available on CD

**300 hi-res images** on one CD rom, There's lots of drawings including pinfire pistols, simple deringers, and Colts revolvers Lugers. and a good group of cannons.

*The Price is a bargain \$40 per disk PLUS SHIPPING. For more information contact Carmen Gianforte at tel 423-559-1546 or by email at [gin40@charter.net](mailto:gin40@charter.net) PLEASE let Carmen know which version of WINDOWS you are using.*

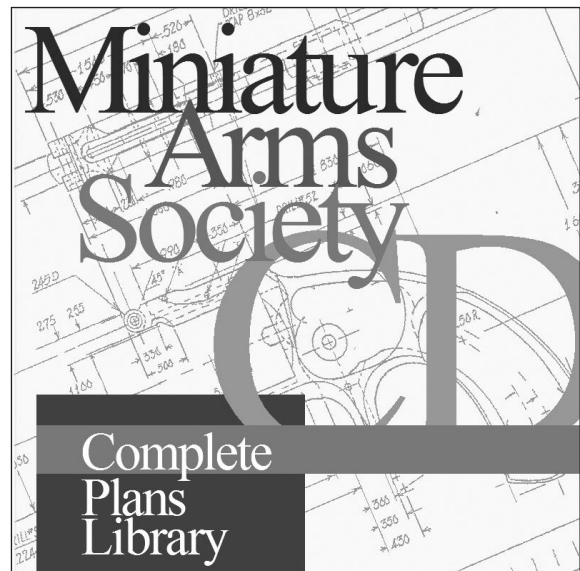





62



Above: Ron DeWalt in 1962 with a La Page pistol that he made while still in High School.

Hi ! Bob

I had a few old photo's, I found the other day of guns I made in High School.... That might be of interest.

A Kid these days making guns in school would have a SWAT-Team outside the building.

The 43 cal. Rifle and the Pocket pistol and miniature English Fowling piece, are still owned by my classmate Jim Marsh. The Le Page is in Ken Whichard collection, He's saving for me. An old neighbor friend has many more guns that I made. I will get over their some day and take Digitals. A lot photos of guns and miniatures are gone and a some I never taken at all. I'll have to sort out the 70's and 80's miniatures pictures and send a long some day.

Happy New Years all  
Ron DeWalt

**ED.** Thanks Ron. We can't wait to see the guns from the seventies and eighties. I've got to tell you, gun making in high school, sure beats learning French.



Above: a 1/3 scale, English Fowling Pistol

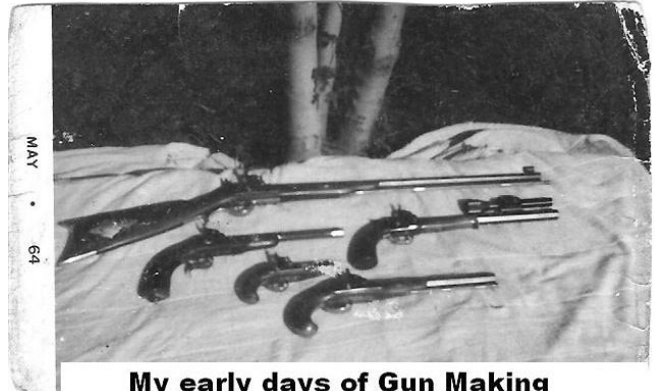

**My early days of Gun Making**

Above: A 43 cal. Rifle, a Le Page, a Solid Frame-Pocket pistol, and a Blazing 45



Full size percussion pistols made in High School, 1961



The bottom pistol is a La Page dueling pistol, made in my senior year '63'



## The Latest from Antonio Rincon

Dear Bob,

All best wishes to you and yours for Christmas and the New Year. The photographs enclosed (top and right) correspond to one garniture set, five pieces, I am completing.

The photo (below right) shows two curiosities in miniature, on the left there is one set trigger with 15 pieces and functional, on the right is one damascus barrel I made many years ago for one garniture set of duelling pistols in 1/5th scale.

I used the same technique that ancient barrel makers used to manufacture damascus barrels.

Best regards  
Antonio,  
Bogota, Colombia

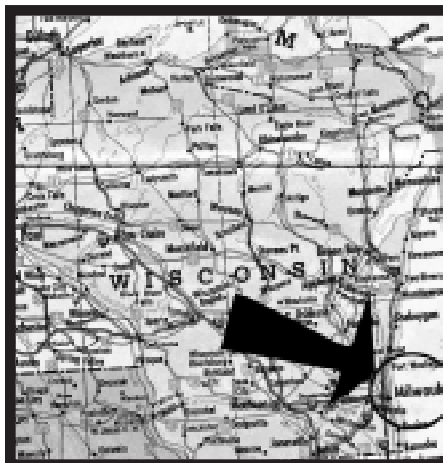

Remember the **NRA Convention** in Milwaukee, Wisconsin **May 19-21, 2006** at the Midwest Airline Center! Information, reservations, maps, etc. are all available at ([www.nraam.org](http://www.nraam.org))  
***The MAS will have it's usual wonderful display, and annual meeting.***

For more information contact Bob or Alice McGinnis  
Tel. (608) 798-2860 - email [mcginnr@chorus.net](mailto:mcginnr@chorus.net)



---

## Carmen Moves In



Hi everybody -

This is a short note—the shop is finally done!!! Now I can begin to move in. Can't wait to get back to work. Hope this note finds everyone well. Here are a couple of misc catch up items.

1st: As you can see from (the photo) my shop is now completed. Now, it's moving time. Over the next couple of months I'll be moving equipment, unpacking about 300 boxes, putting up shelves, etc, etc, etc. Before our move from Florida to Tennessee I had just started some 1/3rd scale Reid knuckledusters. This will be my first priority after I get the shop set up.

2nd: Josie and I attended the Marietta Georgia Antique Gun show last weekend. This is not a large show but a very high quality show. There were no members there from MAS this year. I did see 3 or 4 dealers with miniature guns in their cases. One dealer told me that he sells anything that he can buy.

3rd: For any of our members who are familiar with Reid knuckledusters, no doubt they have seen or read Taylor Bowen's book, "James Reid and His Catskill Knuckledusters". Well there has been a rumor going around for about a year that Taylor had passed away. Let's put this rumor to rest right now. I talked to Taylor last Saturday and he is alive and well. Remember what

Mark Twain said "The rumors of my demise have been greatly exaggerated".

4th: This has nothing to do with anything, but I thought it was interesting and some of our members might enjoy it. You remember all those post cards that keep falling out of the magazines we are trying to read? How do we get these companies to stop putting these cards in our magazines? SEND ALL THESE POSTAGE PAID CARDS IN, BUT DON'T FILL THEM OUT". The companies will have to pay the postage on millions and millions of these cards and get nothing for their money.

That's all for now.  
Take Care  
Carmen Gianforte

---

## Great Fun in VEGAS

Hello Bob,

I just wanted to tell you how much I enjoyed seeing you and your little guns in Las Vegas.

Also I enjoyed meeting Bob and Alice McGinnis and Al Izuka. I learned a lot from Bob and hope to learn even more as he sends some of his machining ideas and connections.

Maybe I will have something for the magazine in the near future.

So long for now,  
Jimmy Thomas

---

## Back Issues?

Bob... Following your plans for Kolibri model 3 which is under construction and coming along nicely. I like your grips much like originals. did you cast these and how did you make the mold and what material did you use ?

Noticed in the last MAS (winter 2005) you have back issues. how far back past winter 2001?

Regards,  
Jim Webster

**ED.** The grips were made, much like printing plates by Owosso Graphic Arts. You can check out their website at <http://www.owossographic.com>

I send them artwork, and they acid etched the designs into copper. I then trimmed, nickel plated, then gold plated the grips.

As for **back issues**, the MAJ goes back to April 1999. Prior to that the issues were edited by Hizzoner Ralph Koebberman, and were called Shooting the breeze.

Our esteemed president, Bill Adrian, has piles of back issues which he will be happy to sell you. You can call Bill at. Tel.(815) 254-8692

---

## Michel Lefavre Honored at Craftsman Website.

Dear Bob,

For the next issue of the MAJ, you can mention that I am featured at the craftsmanship museum website

[www.craftsmanshipmuseum.com/Lefavre.htm](http://www.craftsmanshipmuseum.com/Lefavre.htm)

Always looking forward to hear from you

BST RGDS  
Michel Lefavre

**ED.** We have a pic of this great website on page 33, be sure to check it out. there is a nice long article about Michel, and many excellent, color images of his work.

# Las Vegas Scrapbook



*Above: Californian, Lew Callahan, surrounded by Ken and Coral Whichard from North Carolina.*



*Above: Mal Mele cops a squeeze from Alice McGinnis.*

*Right: Bruce Weiner, from Atlanta, found a few goodies.*



*Above: Bob Urso, Wayne Driskill, and Mal Mele admire one of Wayne's Gatling guns*

*Below: Ron Weingarten had a table of oddities*

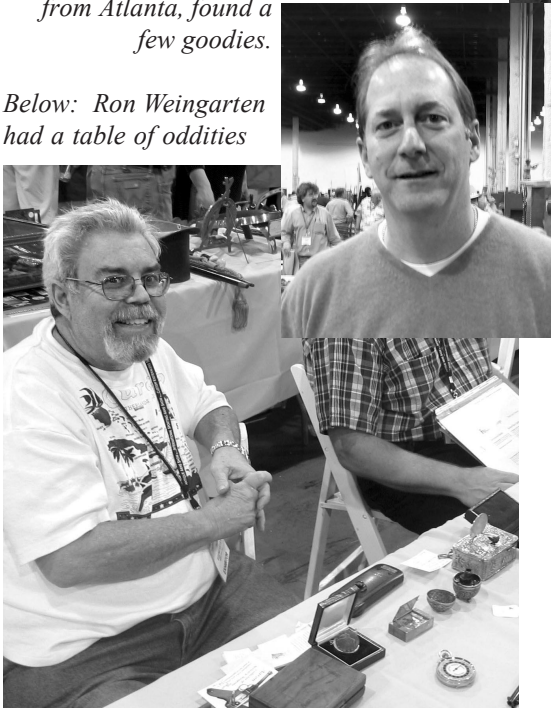

*Right: Ken Taylor, initiating his grandson Kevin into the world of minis.*

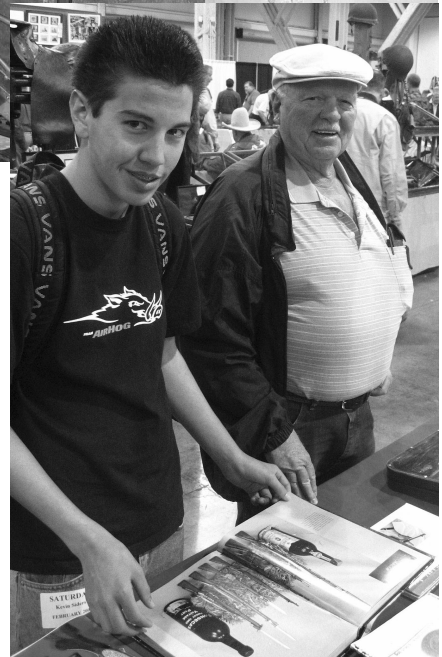





*Left: Californian Ernst Mueller, joins David McMullen from Portland, and Charles McManis around the MAS table.*

*Below: Lew Callahan and Jiggs Caudron.*

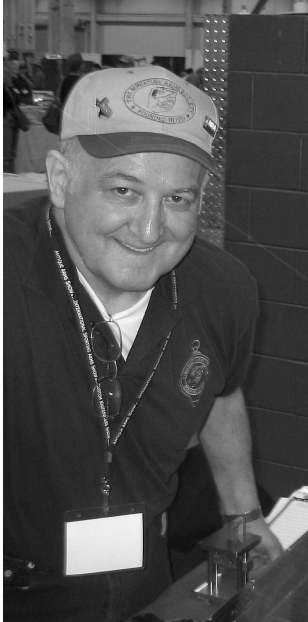

*Right: Victor Vasalli, All the way from New Jersey.*

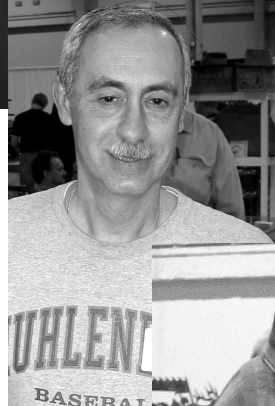

*Right; Tom Selleck, never did stop by the MAS table. Aw shucks!*



*Above: Bob McGinnis doing yoeman duty manning the MAS table.*



*Above: Great conversation from members Gary Lowe, Hawaii's own Al Izuka, and Mr and Mrs. Jimmy Thomas from North Carolina.*

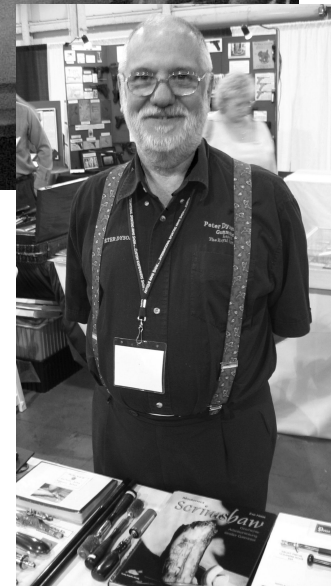

*Above: All the way from England, Peter Dyson.*

# Las Vegas Scrapbook

On this page are a few of the many minis Gary Lowe brought to the show.

*Below: one of the treasures of Gary's collection is this antique Japanese Matchlock.*

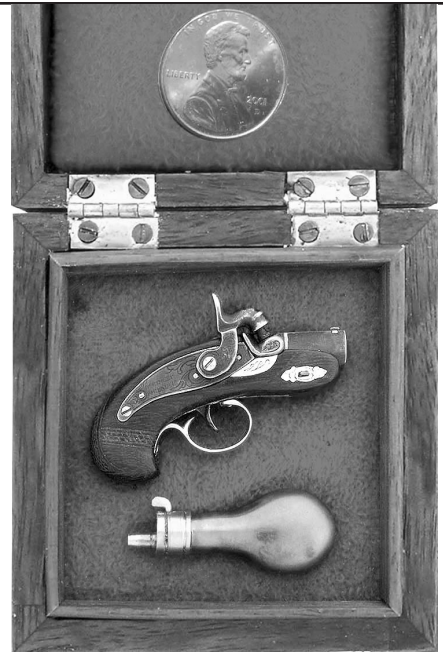
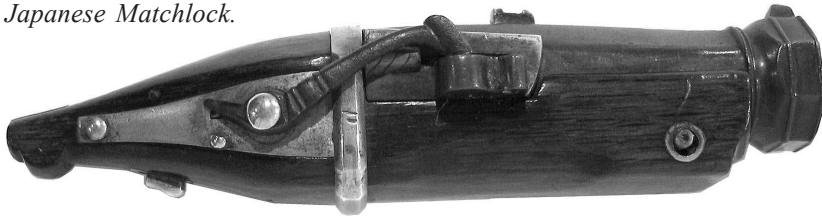

*Above: a 1/3 scale Phila Deringer with rosewood stock, made by Bob Urso..*

*Right and below are two Ron Dewalt pistols. To the right is a 1/3 Scale percussion pistol, and below a 1/2 scale Flintlock. The finish on these was impeccable.*



*Below: a 1/5 scale Colt 1911 Semi-Automatic pistol, in oxidized sterling silver, made by Baez and Kopp.*

*Right: a tiny 14K solid gold, 2mm pinfire, charm pistol, which was made in Florida in the 1950s and originally advertised for sale by Balogh's jewelry for \$1400.*







*Above: This 1.5" underhammer, pinfire wash on display at the MAS table.*



*Above: After taking some time off from mini making, Al Izuka is back at work. His latest effort is the little 2mm rimfire beauty shown above. It's based on the extremely rare, single shot, 3mm Kolibri pistol. He'll also be making this in 4mm rimfire.*

*Below, another Al Izuka underhammer, with screw off barrel and cutlass attached..*



Here are three from the hand of Lew Callahan



*Here's a tiny fellow that Lew Callahan brought along. It's a mini of a mini, a 1/2 scale version of the Tom Weston, Belmex.*



*Above: A 1/2 scale Ruger profile mini that fires 2mm rimfire. This one was based on a Ron Dewalt design that Lew liked.*



*Above: A 1/4 scale Little Scout Rifle, This is the takedown model with both round and Octagonal barrels.*

# Las Vegas Scrapbook

*Below: A great pair of fully functional 1/3 scale Colt 1851 Navy revolvers made by Derek Staines in England.*



*Right: This 1/2 scale side by side sidelock shotgun, has virtually 100% coverage of very fine and tight scrolls by Carlo Pasotti of Italy. with bulino engraved sideplates.*



*Left: Rare to find in miniature is this Colt Flatop with extended grips.*



*Above and Right: A 1/2 scale miniature Winchester Model 1894 take down rifle. Beautifully engraved by Roger Sampson, with the finest checkering by James Corpe. Roger even hand engraved all the markings on the barrel, etc.*







Wayne Driskill with some of the guns from his four tables of fine miniatures.

*Left: Wayne Driskill manning his display of quality minis, including some rare pieces like the Gatling guns in various scales, shown in the photo.*

*Below: a very unusual, and finely detailed anti-aircraft gun. The height on this piece is over 2 feet.*



*Above: A group of Tiffiny gripped Colts with extensive engraving on the frames.*



# Las Vegas Scrapbook



Above: Andrew Dyson, from England, visits the award winning miniature knife display of Tom and Gwen Guinn.



Above: Part of the Guinn collection, The most impressive display of miniature knives this editor has ever seen.



Left: The tiniest knife in the collection is this tiny multi blade knife with MOP scales.



Above: an Yves Vachon masterpiece. this 10 blade Swiss Army knife is less than an inch long when closed.



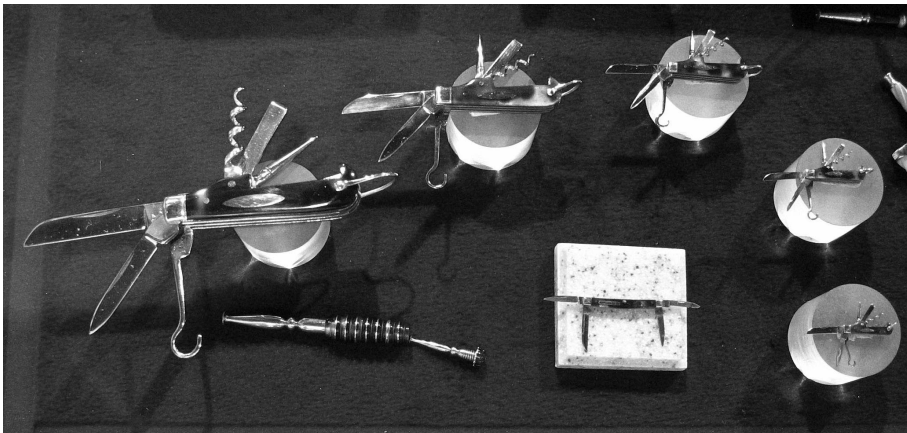

*Left: a group of multi-blade knives in diminishing scales is a favorite theme in Tom and Gwen Guinn's collection. The largest of these knives is less than 1.5" closed, the smallest a mere 1/2".*

*Below: another group of pocket knives in diminishing scales.*



*Above: a damascus blade folder from the Guinn collection. Below a beauty of a folder that less than 1" long closed.*

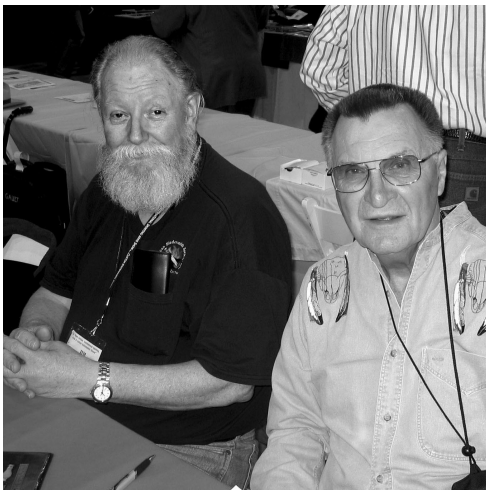
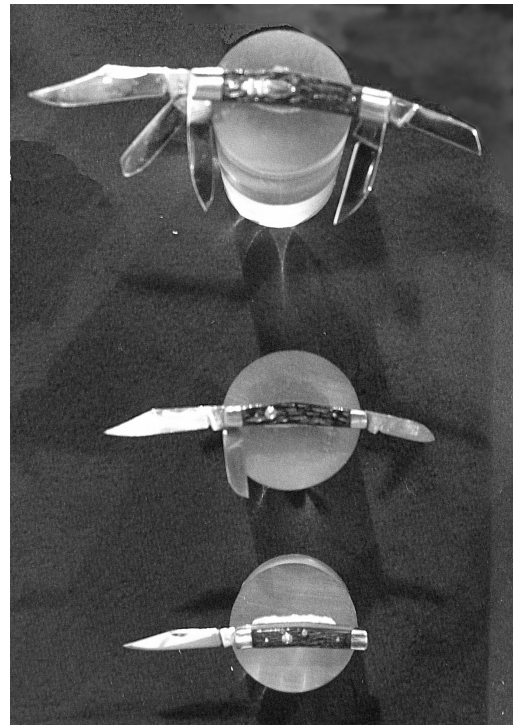
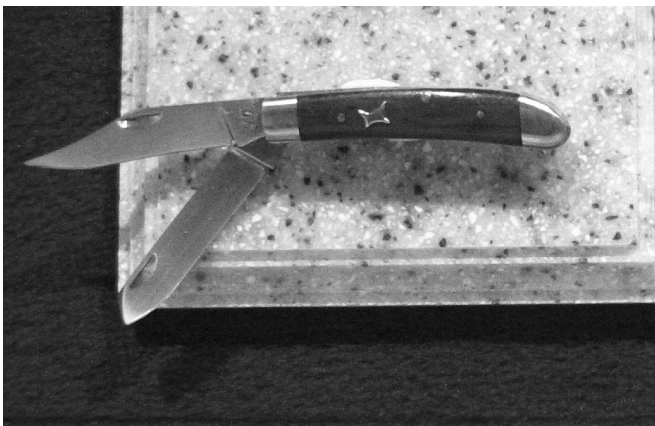

*Left: Jim Whitehead shares a table with Mal Mele. There were just too many Whitehead beauties to show here, so we will be featuring Jim's work in the summer issue of the Journal. Below is just one example of his fine work, and engraving. This knife was quickly snapped up by member Gary Lowe for his collection.*





# The Latest From Roger Sampson: Premier Mini Engraver

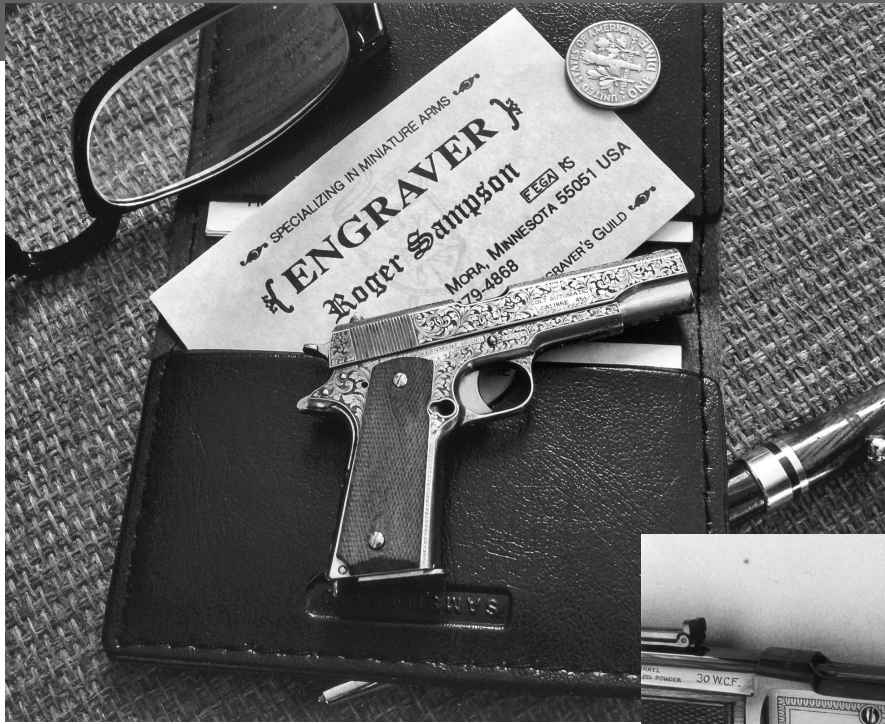

*Above: is a 1/3 scale Colt automatic by David Kucer.*

*Right: A Winchester Model 94 Carbine.*

*Below: A half scale, Rolling Block rifle.*



Recently your humble editor contacted member Roger Sampson for help in identifying an engraver's mark. Roger is the go to guy when it comes to engraving and minis. Although his connections at the Firearms Engravers Guild of America came up blank in their search, contacting Roger reminded me that it's been a while since we featured his work. I asked him for some pics of his latest masterpieces,

and on the next three pages are examples of some of the finest engraving on miniature arms that you will ever see. Roger's work is so good that I'd assumed that he was a full-time engraver, so it was a total surprise when I recently found out that Roger's "real" job is as a pharmacist. Working four days a week as a substitute for area pharmacists that are ill or on vacation leaves plenty of time to create the beauties shown here.

**ED.**





*Left: An 1874 model French Service Revolver.*



*Above: A 1/3 scale, Winchester model 94.*



*Left: Two Uberti made Colts.*



*Right: A half scale Colt Paterson.*



*Left: Two different model Browning Automatic pistols.*

## 1862 Gatling Gun

Dear Miniature Enthusiast:

This is a ¼ scale miniature of a 6 barrel, percussion, 1862 Gatling Gun. It is made of walnut, steel, and brass. It is fully functional but does not fire. The overall measurements are : 26" length, 18" width, and 14-1/2" height. The wheels are 12" in diameter with steel rims. The gun has elevation and will turn.

This gun has a serial # 002 properly marked. Serial # 001 is in the NRA Museum. The price is \$7500.00 plus shipping & handling.

This gun has just been completed & is ready to be shipped. If you are interested or would like further information, please contact me

Ken Horbal, 27 Ardmour Drive, Mastic, New York 11950  
Tel. 631-399-0853 email Jovibabe3285@msn.com

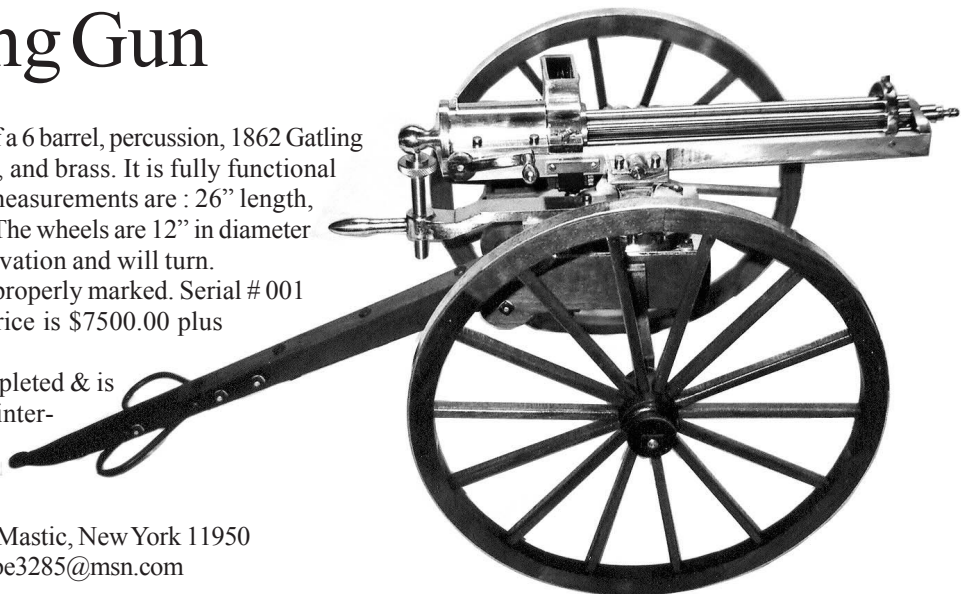



# Miniature Pistol Holsters

by Sterling Kopke

I find it very enjoyable to make & collect miniature pistols & knives. Even though I am 71 years old there is still some little boy in me. After I started making sheaths for some of the miniature knives I've made, I thought why not make a holster for one of my miniature pistols. I chose a little 1930's, 2mm, Fisher Firesure & this is the result.

The first thing we need is a pattern. I chose a style from a Western quick draw holster that I have. I downsized it to my miniature by laying the little pistol on a piece of paper, tracing around it and cutting it out with scissors, then I folded it around the pistol until it looked like it was right. See Fig. 1 & 2.

**Material:** The next step is obtaining material. Most large towns have a store that sells leather supplies. They usually have a box with small scrap pieces. For \$1 I got enough scrap to make several holsters. What works the best is a leather called Police leather. It's about 1/16" thick and comes in brown or black. It is dyed all the way through. The smaller pieces, for the buckle and the tongue, are made of 1/32" flexible, calf leather.

Next we need to carefully layout our pattern on the leather. I find tracing around the pattern with a ballpoint pen works well on black but on light colored leather it will show unless you cut inside your ink lines. I use a sharp Xacto knife to do the cutting. The edges of the leather will be square, but it looks more professional if we round these edges.

Take a 4" long, 3/8" round, hard wood or nylon dowel and cut and file a groove using a drill press or lathe.



See Fig. 5. With this running in your drill press, wet the edge of your leather and run it back and forth. This will round the edge. Don't round the edge of the holster (See dotted lines, Fig. 2) until it is sewn together.

Next comes the sewing. This is really easy when you know how. You will need a small awl, small dividers, some waxed carpet or leather thread and 2 needles big enough for the thread to pass through the eye. Take about a 14" piece of thread & put a needle about 2" from each end. Now with our dividers lightly scratch a line a little over 1/16" from the edge where we are going to sew. Then we set our dividers a little over 1/8" & start on the pistol entry end and lightly mark

a hole, then swing the dividers from one hole to another to get nice equal spacing. Now, take the awl and carefully punch the holes. Fig. 2 shows the stitching technique. Pull each stitch tight & when you get to the end tie a square knot.

Next cut some strips of the 1/32" leather, a little under 3/8" for the buckle and the tongue. You can scale the drawing for these lengths. Make the portion that holds the buckle about 5/16" longer to fold under the buckle to catch the first 2 stitches.

The buckle is made of 1/16" aluminum. Cut a strip 5" wide & a few inches long. Do all the machining you can with it attached to the stock. See





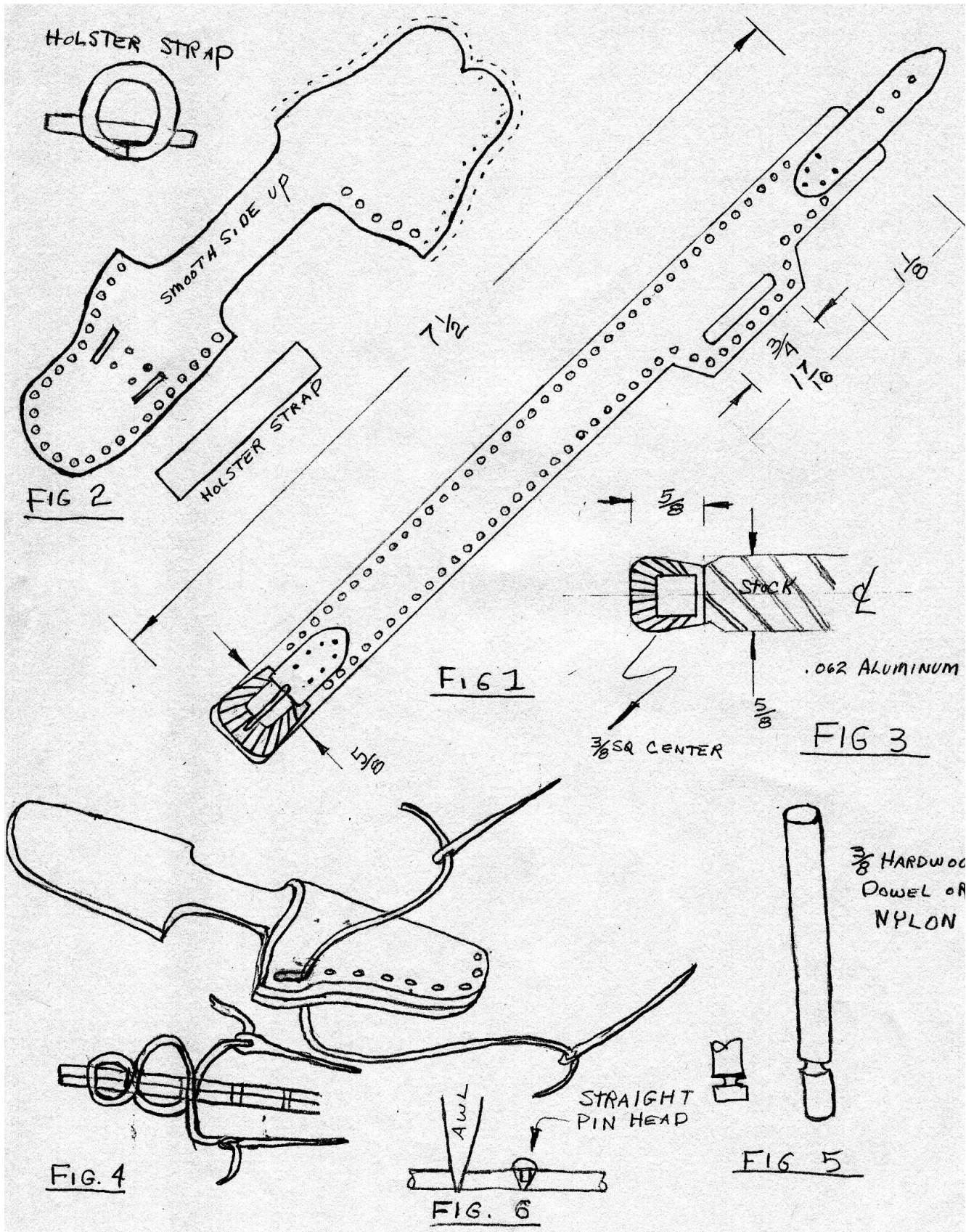



Fig. 3. Lay out the sunburst from the center of the back of the buckle. You can use a black marking pen for your layout ink. Use a chisel and strike just hard enough to leave a nice groove. Finish rounding the edges of the buckle and polish down to 600 wet & dry paper. Polish the buckle on the buffing wheel, then cut the buckle from the stock. This procedure gives you something to hold on to while doing all this work. When you finish polishing make the buckle catch from .025 to .035 wire. Then finally sew the buckle & tongue to the belt.

Now cut a piece of 1/16" leather about 5/16" wide and an inch or so long for the leather strap that holds the front of the holster to the back. See Fig. 2, Fold the front of the holster over where it belongs & mark the sides for the strap. Cut the slots wide enough for the strap to pass

through. Put one side of the strap through the slot & half way to the second slot & put in a stitch. Then wrap the strap around the holster, through the back slot so it butts up to the other end of the strap. Put a stitch through this side & your holster should slide in perfectly.

The next big job is the studs & how the heck do we do that? I have a philosophy if it is not simple something is wrong with it. Usually when you know the trick of doing something it is simple. I discovered the heads of straight pins are about the right scale for the studs. I got into my wife's straight pins & then cut them (side cutters) just a little less than the thickness of the leather or about 1 / 16" long under the head. Layout the holes for the studs with the dividers just like you did with stitching, a little over 1/8" apart & 1/16" from the edge. Lay

the leather on a piece of the soft wood & push your awl into the holes just far enough that the heads will catch on the surface (Fig. 6) After the holes are punched & a bunch of pins cut to 5 mm, you can Epoxy the pins in the holes. Just mix up a couple drops because it will set up before you can install many pins. Anything worthwhile takes a little time & patience.

Put the holster together & then punch a small hole in the bottom of the holster for a leg tie down & hole in the side of the holster top for a trigger tie down. Use your wax sewing thread for this. It looks like rawhide. The final thing is to just sit back & look at what a nice job you have accomplished.

Sterling Kopke  
217 E. Farr St. Tucson, AZ 85705  
smkopke@msn.com



## Herschel Kopp Book Back in Print

Here's a chance to see the beautiful guns sketches, and writings of one of the founding fathers of the Society, Herschel Kopp.

This 96 page, soft bound book costs \$20 per copy plus a shipping and handling charge per book of \$4 for USA, addresses, and \$7 outside the USA. Checks made out to the *Miniature Arms Society*, should be sent to

Alice McGinnis,  
2109 Spring St,  
Cross Plains, WI 53528.

*Below: some sample pages from the book.*





## The Early Days

I like cannons and so I decided to write this little epistle about them and the early attempts at artillery before most cannons were invented. Most of you, if not all of you, are aware of the fact that the Chinese were far in advance of the western world as far as the invention of gun powder is concerned. While the Chinese had as many fights and wars as the so called "Western World" had, once Roger Bacon and Berthold Schwartz (Black Berthold) unleashed the power of gun powder the world was never quite the same any more.

Before gunpowder, the poor, innocent warriors had to make do with the powers of gravity, elasticity of animal sinews and the energy of bent wood, although I must say, they did quite well with the methods they used. They took the relatively weak bow and arrow idea and made it into bigger and more lethal catapults and ballistas. They embraced gravity and used it to make huge trebuchets and used them to hurl projectiles such as stones, Greek fire, loads of manure, dead soldiers and in one case bags of gold coins at or into

the enemy camp. Last, but not least the inventors of the day used the elasticity of wood to push or "spank" arrows at their enemies.

One of the best so-called engines was the catapult. These came in various sizes, ranging from one that threw a fist sized stone or arrow several hundred yards to a monster that was twenty or twenty five feet in height. Most of these were activated by

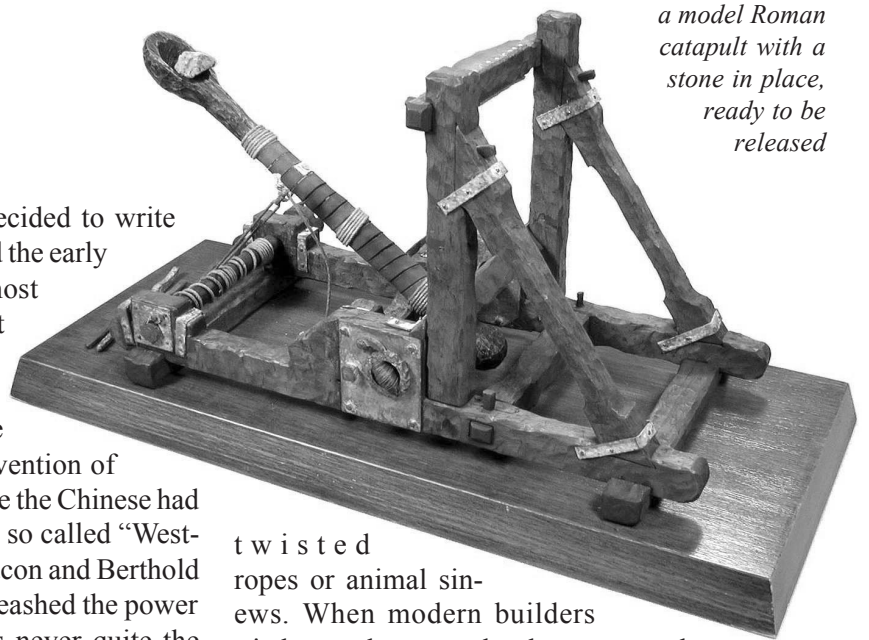

*a model Roman catapult with a stone in place, ready to be released*

twisted ropes or animal sinews. When modern builders tried to make catapults the same as the ancient ones, they found that they had to wind their machines almost to the breaking point to achieve the same results as the ancient machines.

According to ancient records, the Greek and Roman machines could loaf along all day hurling stones farther than the modern prototypes and for much longer times. So much for modern science!

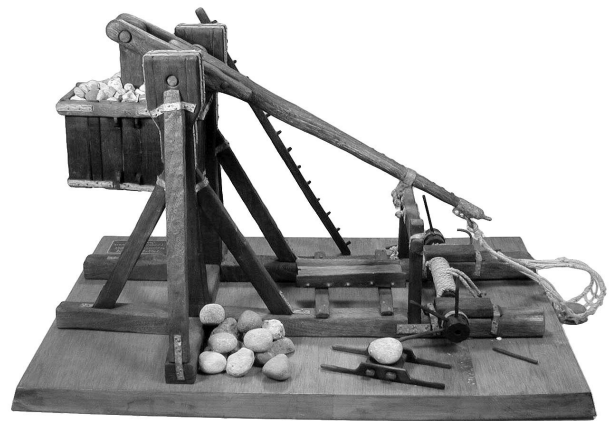

*Above: Trebuchets were developed in the Middle Ages as a siege engine to batter down walls and forts. They were huge and were capable of hurling dead horses and other disease producing objects to start a plague.*

By Ralph Koebberman



The trebuchet was used only for siege work as it was a huge machine and could only be transported by dismantling it to move it. It was powered by gravity, using the weight of a huge box filled with stones hinged to one end of a long beam. The beam was

pivoted near the weighted box with the ammunition (usually a stone) being held in a sling at the other end of the beam. The beam was pulled down, a stone was placed in the sling and the beam was released and swung up, sending the stone on its way to continue to batter down the walls of the besieged town or castle.

Gunpowder opened up new vistas to soldiers for killing their fellow men and commanders were quick to take advantage of it. It did not progress as fast as some commanders would have liked for the usual reasons. Gunpow-

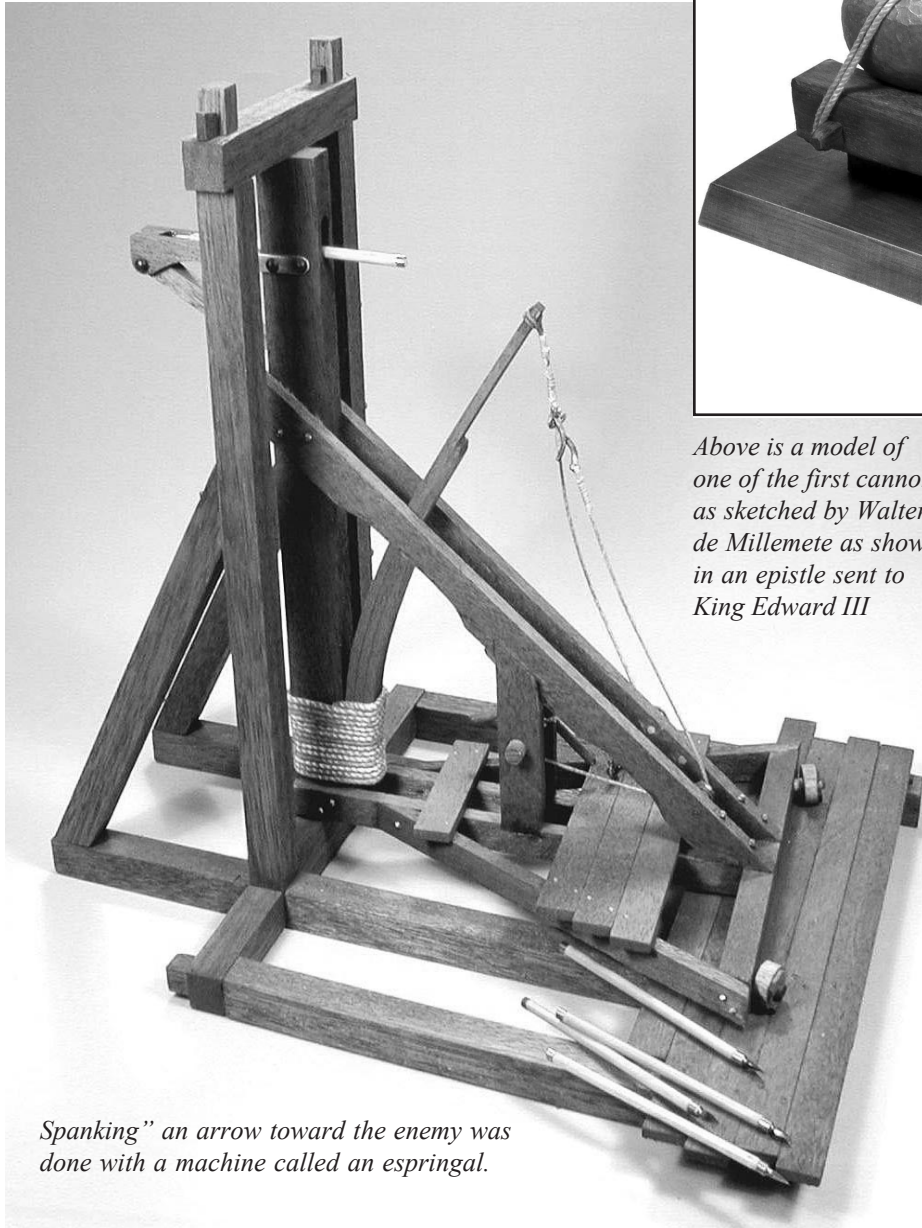

*Above is a model of one of the first cannons as sketched by Walter de Millemete as shown in an epistle sent to King Edward III*

*“Spanking” an arrow toward the enemy was done with a machine called an espringal.*

“Spanking” an arrow toward the enemy was done by a machine that held an arrow in a trough. A board was bent back and suddenly released so as to hit the butt end of the arrow, thus sending it on its way to the enemy. I am sure they tried other means of propelling projectiles of one kind or another, but they really didn’t get the best means of killing their fellow men until they had “GUN-POWDER!”

der was expensive to make and the chemists and manufacturers did not have the means to make large quantities of it in those days. Also the suppliers in those days did not have the means to produce and sell the gun powder’s basic materials of sulfur, saltpeter and charcoal so it was a difficult and expensive product to make.

The first written and illustrated account of a cannon was portrayed in an account dedicated to Edward III by Walter de Millemete. The illustration shows a metal casting shaped like a vase, laying on its side on a rude table with a large arrow protruding from its mouth apparently ready for firing. It didn’t take long for the cannon users to decide that an arrow was not the best projectile and that maybe a round ball was. It was also decided that possibly it was easier (and much cheaper) to have some of the followers busy chipping stones into round balls for ammunitions than to have iron cast into balls for the self same use. The stone balls were not as good (say destructive) as iron balls, since iron was scarce



and expensive and had to be carried to the field of battle whereas stones could be found at any siege or battle location and people were acquainted with the work of shaping stones into a desired shape, which in this case was a round ball.

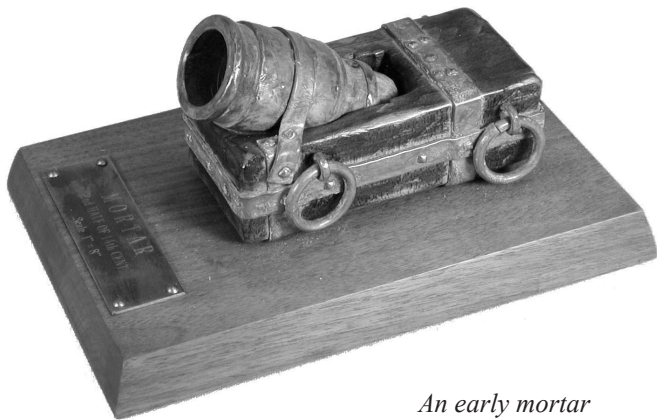

*An early mortar*

From old records it seems that many or most of the first cannons were made in the foundries of people that made bells, because they were experienced in making molds for casting metals and the molds for casting cannons were the same as the ones for casting bells. Of course there were other methods, one of which was using iron bars by welding them around an iron rod which was later removed to form the bore of the cannon. These were sometimes reinforced by welding iron bands around the exterior of the bars. At the time, these latter cannon barrels made by this method were said to have been made by the “hoop and stave” method in reference to the fact that the way they were made was similar to the way wine barrels were made. Some of the first cannons were called mortars because the powder they used was made

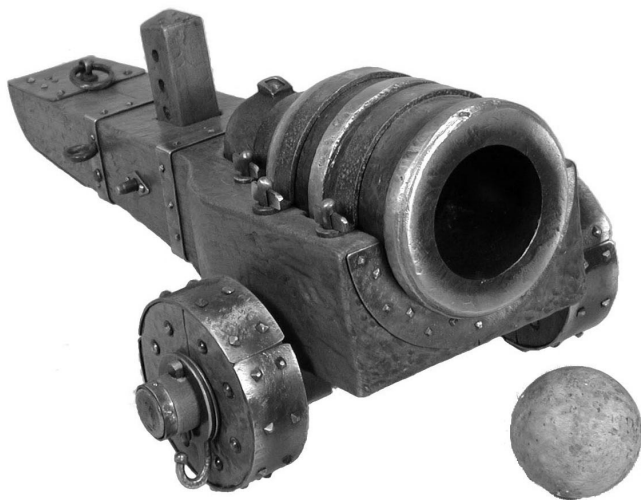

*This picture is of an English 16 inch bombard a little later in style than the earlier ones in the article since it was mounted on a crude carriage*

by grinding the powder in mortars as was used by chemists.

Also they were short and stubby in design and were easy to make in the elementary foundries of those times. Because they did not have long barrels their range was limited when fired horizontally but got better results when firing at a high angle, which enabled them to lob solid shot and hollow “bombs” filled with powder and equipped with rudimentary fuses over castle walls and fortifications.

After the pot de fer and the mortars, one of the next type of cannons was the bombard. These came in a variety of sizes and styles. They could be either muzzle or breech loaded, and often were hauled to the siege in a cart and rather unceremoniously dumped on the ground. A shallow trench was dug under them to act as a buffer to keep the barrel from sliding back and stones or beams were propped under the muzzle to adjust the range. Since the stone or even the iron balls were not a good fit, much of the powder’s power was lost. The bombard had several different names but one of the most probable derivations came from the Italian expression, *bombo et ardore*, meaning thunder and lightning. Some of these were quite huge, with a bore of up to 50 inches and some few were

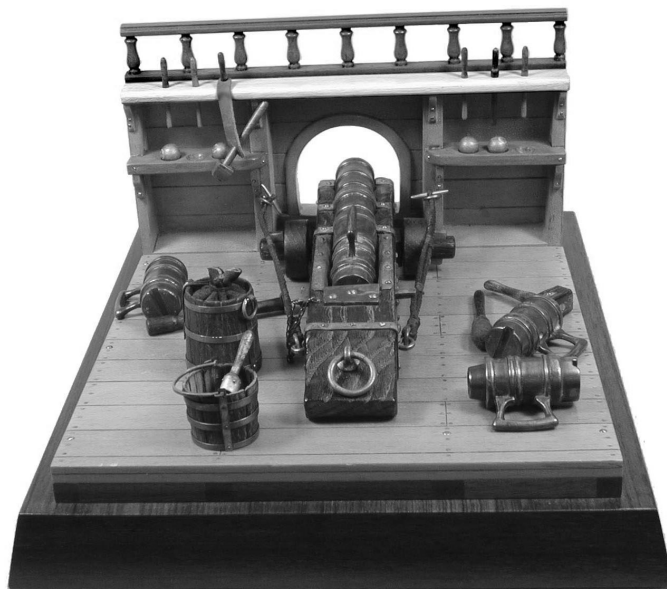

*Above: An Italian serpentine shows a cannon of a type using “thunder mugs”, showing one “thunder mug” in the cannon ready to be fired and three waiting to be loaded.*

One of the next steps was developing the breech loader type of cannons. These appeared late in the 13<sup>th</sup> century and one type called for a new method of loading the charge. This was done by using a sort of metal mug equipped with a handle that held the powder charge and

a wad. After being loaded, the front end was wedged in the breech and held in place with wooden wedges hammered in back of the pot to hold it in place. This had obvious advantages, chief among them being that it enabled the cannon to be fired much more rapidly since the pots could be loaded ahead of time. Then it was just a matter of knocking out the wedges, taking out the empty pot and replacing it with a fresh loaded pot, dropping a new ball down the bore and the cannon was ready to be fired again. Also, if necessary, the pots could be removed before firing and saved for a later engagement. One disadvantage was that the makers had no method of machining the parts and much of the powder's force was lost by leakage. The pots went by several different names, such as "thunder mugs" or "thunder boxes"

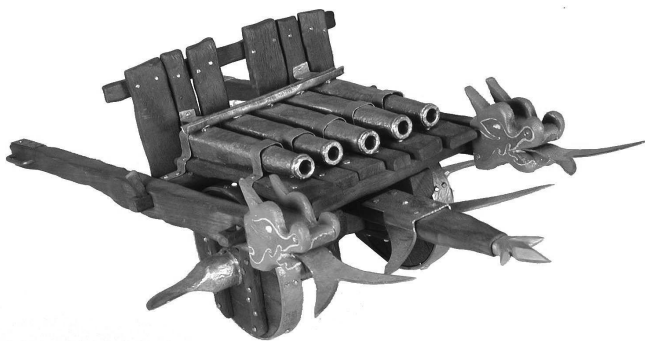

*The rebaudequin was more picturesque than practical, but it did inspire terror in the enemy*

At about this time, the naming of cannon types became somewhat rampant, with names such as falcon, saker, shrimp, bombards, salcons culverins and basilisks appearing. It appears that some of the names came from the men that made a particular type of cannon while others came from the men in the field that used them. One particular type of cannon that gained quite a following was the rebaudequin. A relatively light gun it consisted of anywhere from two to twelve barrels mounted on a light carriage, made so that all the barrels were set off at one time. Some of these were made with blades and spears fastened to the frame that enabled the gunners (if they were brave enough) to pick up the shafts of the carriage and charge the enemy.

This, then was the way artillery developed in the early days before and after gun powder was developed and used. By our use of gun powder and more potent explosives, artillery developed into the frightful and terrible tools of warfare that are used today, which of course, pale in insignificance when they are compared with the awesome power of the atomic bombs that available today. One wonders where it will all end!

# If You Are Not Reading This...

It could be that your forgot to pay your dues...

Remember... **Miniature Arms dues** are due each **JANUARY**. Don't let your membership lapse and find out that you are not receiving this spectacular Journal. Make your **\$30** (\$35 international) check out to *Miniature Arms Society* and mail to

Alice McGinnis,  
2109 Spring St,  
Cross Plains, WI 53528.





# Pinfire Page

By Bob Urso

Days after receiving an email asking for my opinion of the value of this gun, it turned up for bids on the Ebay Auction site. To my surprise, as well as the sellers and many of the collectors who bid on it, last minute bidding jumped the price to \$4,500.

Later, However, I learned that the top two bidders dropped out for various reasons, and the gun was offered to a member for \$2,500. Whether he purchased it is another story.

Despite some roughness, it was a nice gun, nickel plated, with gilt hammer and trigger. The case was most interesting since it had the name of Lefaucheu inside the lid. Could it have been made by the preminent maker of full size pinfire revolvers???



## Southerland Knifepistol Brings Good Price on Ebay.

Here's a John Southerland, 2mm pinfire, knife pistol that also turned up recently on the ebay auction website.

It has 3 blades and mother of pearl scales. The over all length - closed - is 1-1/2". The 5/8" barrel, hammer and trigger are blued.

When the hammer is pulled back and cocked, the trigger drops down between the blades.

Last minute bidding on this little beauty was hot and

heavy, but I'm happy to say that it was won by a member of the MAS.

ED.

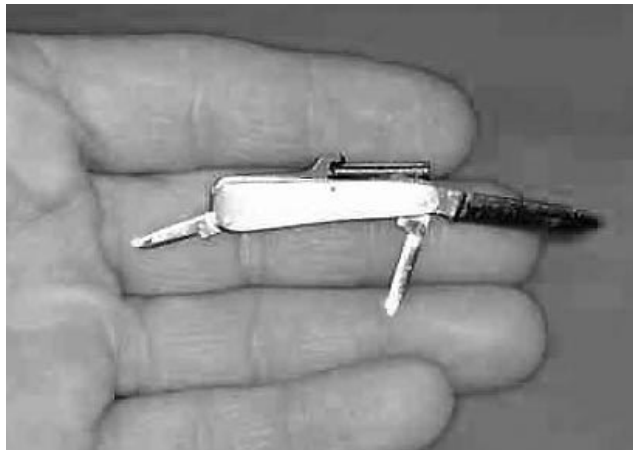

*Below: Shown actual size are two view of The Southerland Knife pistol. Cocked, and ready to fire, and closed*



# 2mm Knuckle Dusters.

By Bob Urso

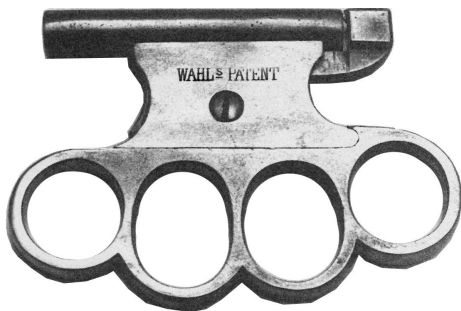

Because of their “oddity” factor, and the simplicity of their design, single shot knuckle duster pistols have been favorites for makers to miniaturize.

The original “knucks”, such as the Wahl’s Patent and the French “Le Centenaire” are very scarce, with - according to some sources - less than 100 having been manufactured.

All are very similar with a smoothbore barrel being attached to brass knuckles, the barrel acting as the palm rest.

Internally they are also similar. The “WAHL’S PATENT” .22, rimfire (shown above) was, according to Bowen in his book “James Reid and his Catskill Knuckledusters” an American copy of a pistol manufactured in France as the “Le Centenaire/ Coup de Poing Pistolet”.

The Wahl’s Patent has a 2-1/2”, smooth bored barrel attached to a four finger set of knucks, which are 4” long. The easily concealable pistol was only 3/8” thick. The Hammer swings up, and strikes the cartridge on the



The French version, upon which the Wahl is based, is different in several aspects. The most obvious being that the earliest versions of “Le Centenaire” (shown above) were percussion, rather than a cartridge pistols. The barrel and knucks were cast in one piece of gun metal.

Markings on the inspection plate include;

“LE CENTENAIRE”  
COUP DE POING PISTOLET Bte. S.G.D.G.

And on each side of the inspection plate screw.

FRANCE  
1789 - 1889

and

AMERIQUE  
1789 - 1889

below which is

DEPOT de PARIS 5 BD de Strasbourg

ARMES & COLLECTIONS  
Magazine no 17 has a description of



Above: A “Le Centenaire” knock off with a different trigger and hammer profile.

Below another, unmarked, copy, with still another hammer design.



the gun written by Monsieur Jean-Pierre Bastie.

Le Centenaire was manufactured, around 1880, to celebrate the 100th anniversary of the French and American revolutions. Because of its simple design, it was easily faked - see above.

*continued...*

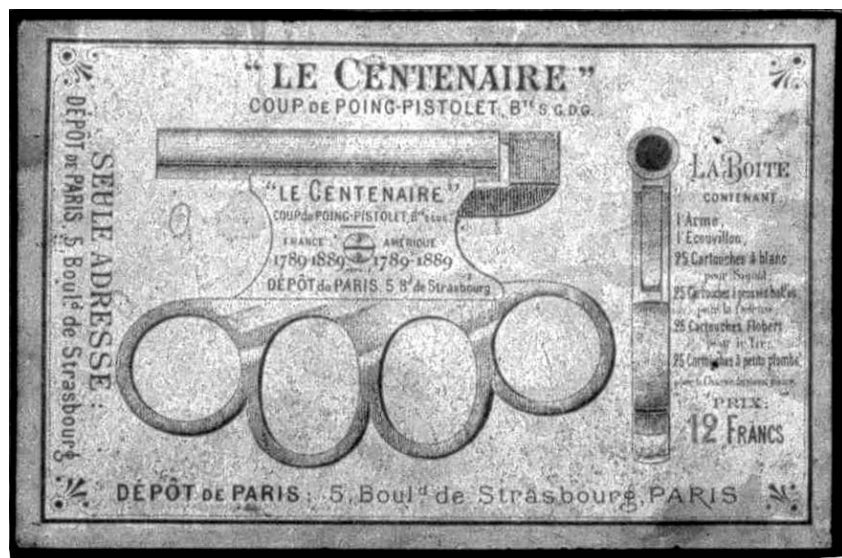

Above: a later, cartridge model of “Le Centenaire”



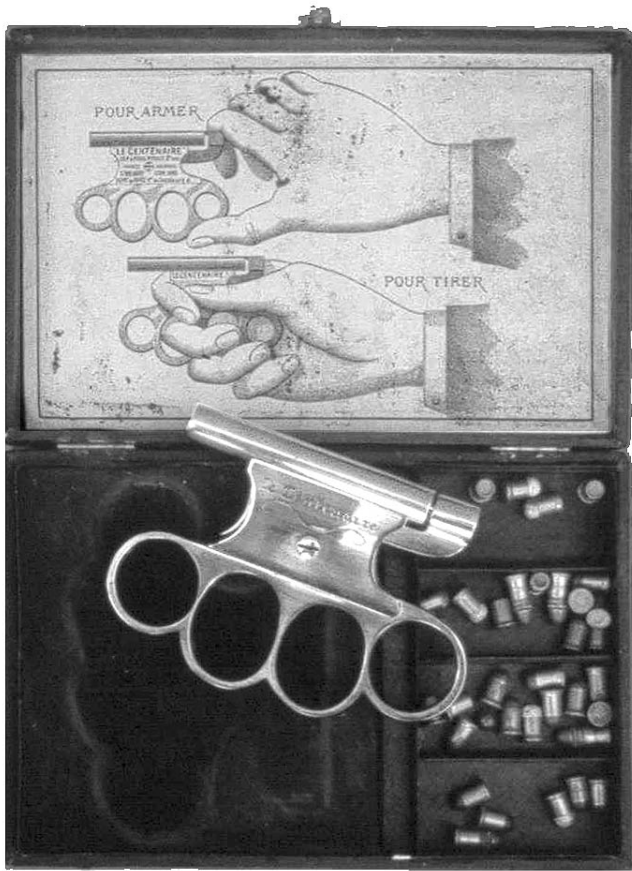

*Left: Still another variation of markings on a "Le Centenaire" The inside cover of the box, however, shows a later cartridge model, with the older original markings.*



*Above: Hersh Kopp's mini version of the Wahl's Patent, cased in a hand made oval pastboard case.*

Because of its simplicity, several mini makers have made this gun with Herschel Kopp's version being the most well known. Herschel documented the trials and tribulations of making this gun in an article for the Societies newsletter called "OH, That Smarts!". The article and Hersch's drawings can be found in a must book for mini makers called "The Odd and Curious, Guns, Knives, and Drawings of Herschel Kopp" (see p. 23 for ordering instructions).

I am now making a version based on Hersch's drawings. They are easily identified since Hersch left his brass guns unplated and unmarked, while mine are engraved with the "WAHL'S PATENT" markings, and are nickel plated.

The frame is cast brass with a steel barrel soft soldered onto it. The hammer is also cast. The trigger was originally cast, but because of the tight fit and thin sear, I've switched to

spring steel, which I can harden.

The main spring is a bit tricky because of the tight fit. The curve in the frame that the bend of the spring tucks into must be large enough so that the spring doesn't slip out when cocking the hammer. The bottom front of the spring must also fit very tightly into a wedge cut into the frame.

There is also a tiny (hard to see in the photo and drawing) wire spring that tucks in behind the hammer and pushes against the trigger.

As with the original, all parts except the springs are polished and nickel plated.

This is a fun gun, not too difficult to make, even with simple tools. All it takes is a bit of patience shaping the brass knucks.

If you have any questions, contact Bob Urso. tel. 360 733-4406 email [boburso@boburso.com](mailto:boburso@boburso.com)

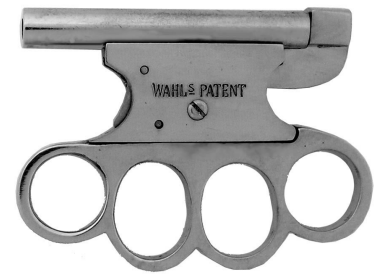

*Above: Bob Urso's mini version of the Wahl's Patent knuckle duster.*



*Above: The simple action of the Wahl's patent knuckle duster.*

Herschel Kopp's drawings of a "WAHL'S PATENT" knuckleduster.

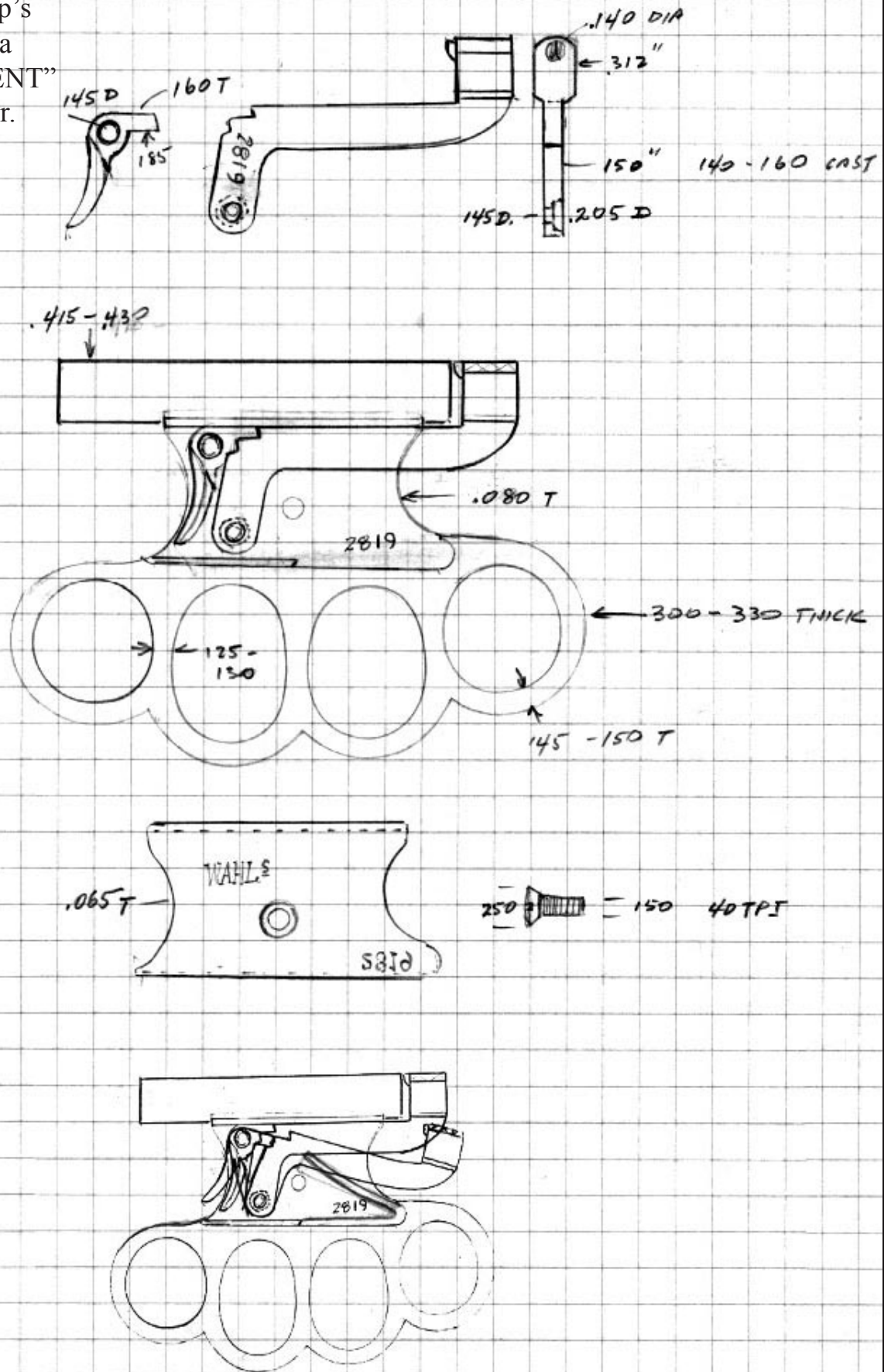



# Web sites worth checking out...

- The Miniature Arms Society Site - by Brad Maxfield ..... [www.miniaturearms.com](http://www.miniaturearms.com)  
 Piccolo Miniature Gunworks - Bob Urso's site ..... <http://www.boburso.com>  
 Pinfire - Derek Dredge's site ..... <http://pinfire.homestead.com/MiniaturePinfires.html>  
 Paul Gauffins has a website "Small Arms Specialists" ..... <http://www.miniguns.com>  
 Peter Dyson and Sons, England ..... <http://www.peterdyson.co.uk/>  
 Cyrus Kemps pinfires for sale at ..... <http://www.cyruskemp.com>  
 David Kucers web site is at ..... <http://www.kucer.homestead.com/files/>  
 See Dan Osterman's minis at - ..... <http://www.OstermanMiniatures.com>  
 See Lew Callahan's minis at - ..... <http://home.earthlink.net/~lwcallahan1/lewsminiatures/>  
 Imperial Miniature Arms at - ..... <http://www.1800miniature.com>  
 Robin Armstrongs guns - ..... [www.armstrong-miniatures.com](http://www.armstrong-miniatures.com)  
 Uberti miniatures at - ..... <http://www.uberti.com>  
 Yves Vachon mini knives at - ..... [http://www.geocities.com/yvonvachon/fram\\_vachon.html](http://www.geocities.com/yvonvachon/fram_vachon.html)  
 Richard Koury has a website listing miniatures for sale at ..... <http://www.kouryinvestments.com>  
 For waxes and cleaning products, check out Dennis Blaine's Renaissance Wax site ..... <http://www.renwax.com>  
 R. Boos Miniature Knives. .... <http://www.compusmart.ab.ca/arabesqu/rbminis/index.html>  
 Palmers Armoury mini cannon site ..... <http://www.palmersarmoury.co.za>  
 Wayne Driskill Miniatures at ..... [www.waynedriskillminiatures.com](http://www.waynedriskillminiatures.com)  
 Patent Searches ..... <http://patft.uspto.gov/netahtml/srchnum.htm>  
 Swiss Mini Guns ..... <http://www.swissminigun.com>  
 Miniature Knifemakers/Collectors Society ..... [Http://www.theblacemaker.com/mkcs](http://www.theblacemaker.com/mkcs)  
**George Jones - Model maker, and mini-mini gun maker** ..... <http://www.georgewjones.com/>



*Member George Jones, a top model maker for Hollywood has a fun website at [www.georgewjones.com](http://www.georgewjones.com)*

If you try to visit one of these sites, and the URL is dead, please email [boburso@boburso.com](mailto:boburso@boburso.com), and we'll take it off the list. Also please contribute any interesting sites so you can share them with members.



*' Member Michel Lefaivre is featured at the craftsmanship museum website. You can read about Michel and his guns at [www.craftsmanshipmuseum.com/LeFAivre.htm](http://www.craftsmanshipmuseum.com/LeFAivre.htm)*

*ED. and see lots of great images of his guns.*

# Wired...



Below are members email addresses.

PLEASE if your email address changes  
be sure to email [boburso@comcast.net](mailto:boburso@comcast.net)

Adrian, Bill ..... [MAS-MEMSHIP@msn.com](mailto:MAS-MEMSHIP@msn.com)  
 Alley, James ..... [jalley@woh.rr.com](mailto:jalley@woh.rr.com)  
 Armstrong, Robin ..... [jandr.armstrong@virgin.net](mailto:jandr.armstrong@virgin.net)  
 Ault, Garry ..... [gault2112@charter.net](mailto:gault2112@charter.net)  
 Bartram, Barry "Bear" ..... [bbartram@greeleyschools.org](mailto:bbartram@greeleyschools.org)  
 Bilbow, Alan ..... [abilbow@worldnet.att.net](mailto:abilbow@worldnet.att.net)  
 Bilbow, Yolanda ..... [ybilbow@worldnet.att.net](mailto:ybilbow@worldnet.att.net)  
 Boyce, Robert ..... [rdboyce@nidaho.net](mailto:rdboyce@nidaho.net)  
 Brownell III, Frank ..... [fbrownell3@aol.com](mailto:fbrownell3@aol.com)  
 Callahan, Lew ..... [LWCallahan1@earthlink.net](mailto:LWCallahan1@earthlink.net)  
 Campbell Sr., Ted ..... [tedsouper@aol.com](mailto:tedsouper@aol.com)  
 Dalby, Cranford ..... [cdalby@comcast.net](mailto:cdalby@comcast.net)  
 Day, James Jr. .... [jamesdayjr@aol.com](mailto:jamesdayjr@aol.com)  
 DeSmidt, Gary ..... [gadesmidt@westerncom.net](mailto:gadesmidt@westerncom.net)  
 Dredge, Derek ..... [derek.dredge@lond-amb.nhs.uk](mailto:derek.dredge@lond-amb.nhs.uk)  
 Dyson, Andy ..... [andrew@peterdyson.co.uk](mailto:andrew@peterdyson.co.uk)  
 Dyson, Peter ..... [peter@peterdyson.co.uk](mailto:peter@peterdyson.co.uk)  
 Fujise, Joe ..... [funforsale@aol.com](mailto:funforsale@aol.com)  
 Friestad, Roland ..... [cardinal.eng@gallatinriver.net](mailto:cardinal.eng@gallatinriver.net)  
 Gerber, Jack ..... [jackgerber@comcast.net](mailto:jackgerber@comcast.net)  
 Gauffin, Paul ..... [miniguns@empire.net](mailto:miniguns@empire.net)  
 Gianforte, Carmen ..... [gin40@charter.net](mailto:gin40@charter.net)  
 Gianforte, Joanne's: ..... [tennpetite@charter.net](mailto:tennpetite@charter.net)  
 Guerra, Juan ..... [juanmg@msn.com](mailto:juanmg@msn.com)  
 Heap, Geoff ..... [anita-geoff.heap@virgin.net](mailto:anita-geoff.heap@virgin.net)  
 Hernandez Munostes, Luis ..... [1hmguns2@hotmail.com](mailto:1hmguns2@hotmail.com)  
 Hintz, Jon ..... [jehintz.@yahoo.com](mailto:jehintz.@yahoo.com)  
 Hulsen, Chris ..... [hulsencs@hotmail.com](mailto:hulsencs@hotmail.com)  
**Izuka, Al** ..... [albertizuka2004@yahoo.com](mailto:albertizuka2004@yahoo.com)  
 Jones, Ed ..... [suej7@earthlink.net](mailto:suej7@earthlink.net)  
**Jones, George** ..... [moviemodels4@aol.com](mailto:moviemodels4@aol.com)  
 Koebberman, Ralph ..... [rkebby@aol.com](mailto:rkebby@aol.com)  
 Kolligs, Walt ..... [horseandhorse@aol.com](mailto:horseandhorse@aol.com)  
 Kopke, Sterling ..... [smkopke@msn.com](mailto:smkopke@msn.com)  
 Kopsch, Paul ..... [mjkops@yahoo.com](mailto:mjkops@yahoo.com)  
 Korn, Harry David ..... [harrydkorn@yahoo.co.uk](mailto:harrydkorn@yahoo.co.uk)  
 Koury, Rich ..... [richkoury@yahoo.com](mailto:richkoury@yahoo.com)  
 Kouznetsov, Victor ..... [kouznet@attglobal.net](mailto:kouznet@attglobal.net)  
 Kucer, David ..... [DMKucer@aol.com](mailto:DMKucer@aol.com)  
 Lefavre, Michel ..... [michel.lefavre@libertysurf.fr](mailto:michel.lefavre@libertysurf.fr)  
 Loos, Henry C. .... [hcloos@adelphia.net](mailto:hcloos@adelphia.net)

Lowe, Gary ..... [jglowe@floorboxes.com](mailto:jglowe@floorboxes.com)  
 Macias, Mike ..... [mike.macias@fluor.com](mailto:mike.macias@fluor.com)  
 Maxfield, Dr. Brad ..... [maxfield@mcw.edu](mailto:maxfield@mcw.edu)  
 McGinnis, Alice ..... [mcginnr@chorus.net](mailto:mcginnr@chorus.net)  
 McGinnis, Bob ..... [mcginnr@chorus.net](mailto:mcginnr@chorus.net)  
**McManus, Charles** ..... [cemcmly@earthlink.net](mailto:cemcmly@earthlink.net)  
**Mele, Mal** ..... [mal@airmail.net](mailto:mal@airmail.net)  
 Morris, Wayne A. .... [wmorris2@cfl.rr.com](mailto:wmorris2@cfl.rr.com)  
 Morrow, Joel ..... [joel@1800miniature.com](mailto:joel@1800miniature.com)  
 Nelson, David ..... [davidn4329@aol.com](mailto:davidn4329@aol.com)  
 Olsen, Ron ..... [rono438@aol.com](mailto:rono438@aol.com)  
 Perkins, David ..... [davidperkinssj@yahoo.com](mailto:davidperkinssj@yahoo.com)  
 Reinhard, Carl ..... [creinhard@mindspring.com](mailto:creinhard@mindspring.com)  
 Rhoads, Forrest A. .... [farwestr@dslextreme.com](mailto:farwestr@dslextreme.com)  
 Rudich, William ..... [billrudich@aol.com](mailto:billrudich@aol.com)  
 Safer, Bill ..... [wsafer@charter.net](mailto:wsafer@charter.net)  
 Sampson, Roger ..... [rsampson@ecenet.com](mailto:rsampson@ecenet.com)  
 Snowden, Chuck ..... [CLSnowden@aol.com](mailto:CLSnowden@aol.com)  
 Staines, Derek ..... [CARP6218@aol.com](mailto:CARP6218@aol.com)  
 Stearns, Stanley ..... [stst@friend.ly.net](mailto:stst@friend.ly.net)  
 Stumpp, George B ..... [gbstumpp@aol.com](mailto:gbstumpp@aol.com)  
 Tom Tinker ..... [TTinker4@aol.com](mailto:TTinker4@aol.com)  
 Toppel, Karl ..... [Karl.Toppel@ProcessPlants.BOC.com](mailto:Karl.Toppel@ProcessPlants.BOC.com)  
 Trester, Verne ..... [verne.trester@juno.com](mailto:verne.trester@juno.com)  
 Urso, Bob ..... [boburso@comcast.net](mailto:boburso@comcast.net)  
 Watkins, Joel ..... [jebst@swbell.net](mailto:jebst@swbell.net)  
 Weingarten, Ron ..... [doronron1946@aol.com](mailto:doronron1946@aol.com)  
 Weinstein, Alan ..... [tlviking@aol.com](mailto:tlviking@aol.com)  
 Wenzek, George ..... [gwenzek@aol.com](mailto:gwenzek@aol.com)  
 Whichard, Ken ..... [kwhichard@cox.net](mailto:kwhichard@cox.net)  
 Wegrzyn, Edward ..... [ejwegr@peoplepc.com](mailto:ejwegr@peoplepc.com)  
 Whitehead, Jim ..... [jdwmks@centurytel.net](mailto:jdwmks@centurytel.net)  
 Williams, Charlie ..... No longer on the internet... Call him  
 Williams, Jim ..... [cwilliams@infoave.net](mailto:cwilliams@infoave.net)  
 Zimmerman, Kent George ..... [kzimmerman@juno.com](mailto:kzimmerman@juno.com)



## Fixes & Changes

Please note these changes in you members directory.

Correct or new email address

**George Jones** ..... [moviemodels4@aol.com](mailto:moviemodels4@aol.com)  
**Izuka, Al** ..... [albertizuka2004@yahoo.com](mailto:albertizuka2004@yahoo.com)  
**Mal Mele** ..... [mal@airmail.net](mailto:mal@airmail.net)  
**Charles McManus** ..... [cemcmly@earthlink.net](mailto:cemcmly@earthlink.net)

Correct Phone number

**Kenneth Roach** ..... (250-587-6381)



# SHOP-r-SWAP

**Classified** ads from members or nonmembers, are free. They can be any length - within reason, as long as they pertain to buying, selling, or swapping. A limited number of pages are allowed.

**Display** ads must be submitted in camera ready or digital form, and must be accompanied by a check (to Miniature Arms Society). Rates are as follows

	Members	Non-Members
1/4 page	25.00	30.00
1/3 page	35.00	40.00
1/2 page	50.00	60.00
2/3 page	70.00	80.00
3/4 page	75.00	90.00
Full Page	100.00	120.00
Back Cover	150.00	180.00
Bus. Card Free	Free	
Classified Free	Free	

## Shop-r-Swap is FREE

Satisfied with your collection? If not, try an ad. To place a want ad, mail text

and pics to

Bob Urso,  
1806 Samish Way,  
Bellingham, WA  
98229

or send them via  
email to

[boburso@boburso.com](mailto:boburso@boburso.com)

## Abel's Cannon Catalog

For Sale: Robert Abel's 1961 cannon catalog of the Howard K. Brown collection, 56 pages of photos - great for reference when making cannon models.

Price \$15 including postage. Pages are 7 by 11 with slight yellowing otherwise Fine. Call or e mail to hold.

[hcloos@adelphia.net](mailto:hcloos@adelphia.net)  
561 352 8172

Henry Loos  
542 Tomahawk Ct.  
Palm Beach Gardens, FL 33410

## Colt Navy accessories...

Half scale accessories for Colt Navy 1851.



Powder flask. \$ 125.00

Bullet mould \$ 110.00

Semi precious wood box \$125.00

Cap Box \$ 55.00 Discount for quantities

For more information contact

William Adrian

Tel. Tel. (815) 254-8692

## Wahl's Patent Pinfire



Now in production, Price for this pistol is \$360 plus shipping.

For more information, see page 29 or (after May 10)

call Bob Urso at 360 733-4406 or  
via email [boburso@boburso.com](mailto:boburso@boburso.com)

## Wanted to buy:

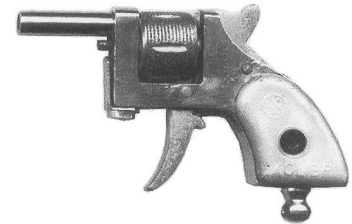

**KOLIBRI, 2mm  
Rimfire Revolver**

Bob McGinnis

608-798-2860

[mcginnr@chorus.net](mailto:mcginnr@chorus.net)

SPECIALIZING IN MINIATURE ARMS

**{ ENGRAVER }**

**Roger Sampson**

FEGA KS

2316 MAHOGANY ST. MORA, MINNESOTA 55051 USA  
320-679-4868

PROFESSIONAL MEMBER FIREARMS ENGRAVER'S GUILD

## Cutlass Pinfire



Here is the latest Bob Urso Pinfire. The design is based on the Elgin Cutlass pistol, and the Austrian Pinfires. The grips are gold plated cast brass, with the mold taken from an original set of grips which I hand engraved. All other parts are nickel plated steel.

I'll be on vacation until May 10th. When I return, I'll continue production of this pistol. You can email me to get on the "to Make" list, but please do not call until May 10th. Price... \$360 plus shipping.

I also have a few extras for sale

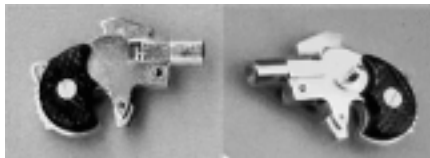

Anders Dworski Cap gun. This is probably the smallest cap gun ever put into production. It fires a proprietary, tiny plastic, cup, cap. This one has a loop on one side for use as a cufflink. Price \$55.

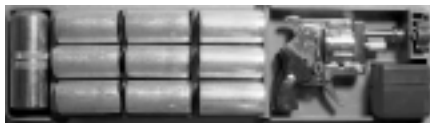

Here is the original Xythos revolver with flare kit, and a box of 2mm pinfire ammo. Mint. \$100

To reserve these, or for more information,

email me at [boburso@boburso.com](mailto:boburso@boburso.com) or call 360 733-4406 (after May 10th)

# Books by MAS Members

## \$20- Blowout price on Mini Artillery Book by Koebberman



The history of artillery in miniature. Members price at cost - \$20 each, plus \$6.75 S&H fee for one book - (\$1 for each additional). From Ralph Koebberman, 4075 Kilburn Ave., Rockford, IL, 61101 phone at (815) 963-1466

## Gold Colts by Nelson Perry

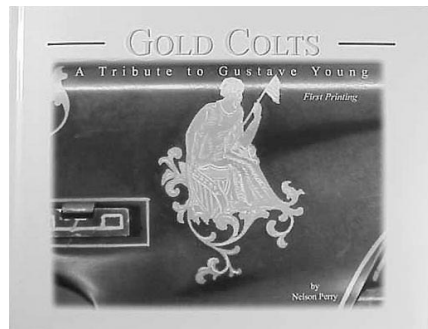

A pictorial study of the percussion Colt revolvers that were engraved and gold inlaid by master engraver Gustave Young. This was written by recently departed MAS member Nelson Perry. 8 3/4" X 11 5/16" in size, hardbound with color dust jacket. First printing, 206 pages, hardbound with color dust jacket  
Numbered hardback copy with color dust jacket: \$60.00  
Numbered leather bound copy: \$120.00

Contact Wayne Driskill  
[driskill@hotmail.com](mailto:driskill@hotmail.com)  
(281)485-1830 Office  
(281)468-7103 Cell

## Great Arms of A. Rincon

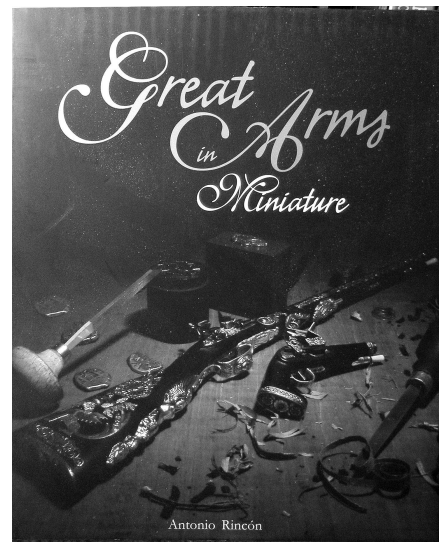

A beautifully printed, full color, history of arms, featuring the miniatures of member Antonio Rincon of Colombia. 218 pages, hardcover, large format - 12" x 10" - fully illustrated, with dust jacket. \$90 To order, contact Alice McGinnis 2109 Spring Street Cross Plains WI 53528 Tel. (608) 798-28860

## The Tiniest Guns by Bob Urso

This second edition -greatly expanded to 128 pages - is the only reference for collectors of 2mm pinfire and rimfire berloque and charm pistols. It is available for \$20 post paid in the USA. \$24 to Europe. \$25 everywhere else. To order contact Bob Urso, 1806 Samish Way, Bellingham, WA 98229 - Tel. (360) 733-4406 - email [boburso@comcast.net](mailto:boburso@comcast.net)

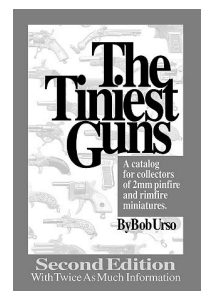



# Wayne Driskill

## Miniature Firearms

Pearland, Texas - Tel. (281)485-1830 or (281)468-7103

[www.waynedriskillminiatures.com](http://www.waynedriskillminiatures.com) or [waynedriskill@waynedriskillminiatures.com](mailto:waynedriskill@waynedriskillminiatures.com)

Uberty miniatures will continue to be available, but the prices have gone up drastically! I still have a great selection at the old prices, but will be forced to raise my prices soon. Get yours now before the price increase.

### New Items:



1/4 scale brass barreled **blunderbus** by **Stanley Blashak**. See page 92 of *The Art of Miniature Firearms*. \$3,500.00



1/4 scale **French MAS 1918** semi-automatic rifle. Unknown maker. Most parts made of brass. Walnut stocks. Aluminum buttplate. Partially functional. Nice workmanship and I'm sure a one-of-a-kind piece. \$850.00

Miniature **German 88mm anti-aircraft gun**. Breach loader, rifled steel barrel, chambers .38 special. Functional recoil damper and elevation assist. Missing firing pin and spring. Because of the castings and steel metal work involved I believe this to be a factory made piece, possibly from the German factory that made the full size guns. Fantastic workmanship and attention to detail. \$4,500  
Miniature



**German 120mm field gun**. Breach loader, rifled steel barrel, chambers .38 special. Functional recoil damper and elevation assist. Missing firing pin and spring. One look at this miniature and you know it was made by the same factory or person as the miniature above. Another wonderful piece! \$5,700.00

Wayne Driskill  
Miniature Firearms  
(281)485-1830 - Office  
(281)468-7103 - Cell  
Websites:  
[www.miniaturefirearms.net](http://www.miniaturefirearms.net)  
[www.waynedriskillminiatures.com](http://www.waynedriskillminiatures.com)